

# TB-Q08-0.15-RS4.47T/C53

## HF Read/Write Head – For Bus Line Topology with TBEN-\*

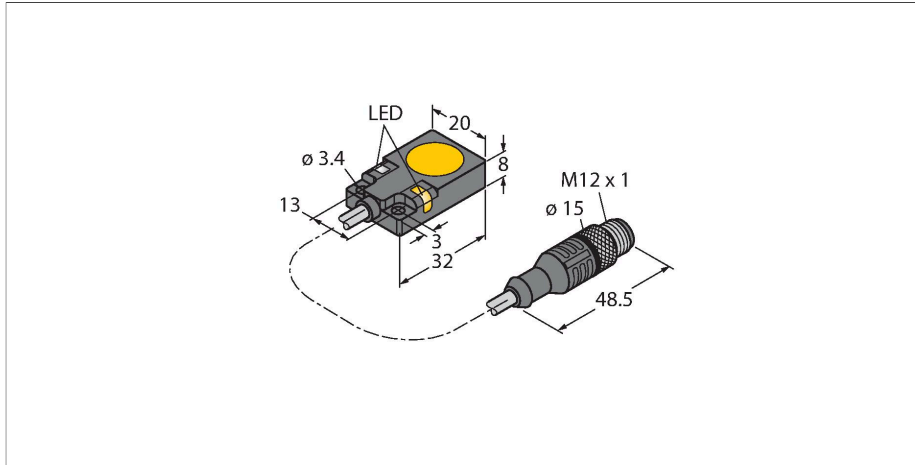

### Technical data

Type	TB-Q08-0.15-RS4.47T/C53
ID	7030778
Remark to product	ultraflat design
Approvals	CE UKCA UL
Radio approvals	EU/RED: Europe UK SI 2017/1206: United Kingdom FCC: USA MIC: Japan EU/RED: Europe
<b>Electrical data</b>	
Operating voltage	10...30 VDC
DC rated operational current	≤ 30 mA
inrush current	700 mA For: 1 ms
Data transfer	Inductive coupling
Technology	HF RFID
Operating frequency	13.56 MHz
Radio communication and protocol standards	ISO 15693 NFC Typ 5
Read/Write distance max.	30 mm
Output function	4-wire, Read/Write
Suitable for bus mode to TBEN-*	Yes
<b>Mechanical data</b>	
Mounting conditions	Flush, flush mountable
Ambient temperature	-25...+70 °C
Design	Rectangular, Q08
Dimensions	32 x 20 x 8 mm
Housing material	GD-Zn
Active area material	Plastic, PA12-GF30, yellow

### Features

- Rectangular, height 8 mm
- Active face on top
- Metal, GD-Zn, nickel-plated brass
- Device without end termination
- Device may only be operated in line topology TBEN-S\*-2RFID-\* or TBEN-L\*-4RFID-\*
- Max. 32 nodes per line or connection permitted
- Use a corresponding terminating resistor (see accessories)
- Observe the performance of the power supply, especially when turned on, and the maximum current carrying capacity of the cables
- Observe the voltage drop on the line
- The maximum possible length of the spur line is 2 m
- The maximum possible length of the bus is 50 m
- By default, a command can only be processed by one read/write head, making HF bus mode suitable for static applications and slow dynamic applications
- In continuous HF bus mode, a command is executed simultaneously on all read/write heads in a bus topology. The recorded data is stored in the ring buffer of the module
- The read/write head is automatically assigned an address
- For different application requirements, the address and can be parameterized
- Powered and operated only via connection to BL ident interface module
- M12 × 1 connector, connection only via BL ident extension cable

### .../S2503 Connectors

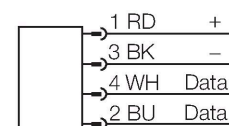

## Technical data

Vibration resistance	55 Hz (1 mm)
Shock resistance	30 g (11 ms)
Protection class	IP67
Electrical connection	Cable with connector, M12 × 1
Cable quality	Gray, 0.15 m
MTTF	391 years acc. to SN 29500 (Ed. 99) 40 °C
Power-on indication	LED, Green
Cable jacket	Gray
Packaging unit	1

## .../S2500 Connectors

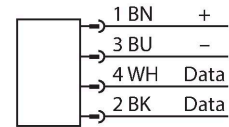

## .../S2501 Connectors

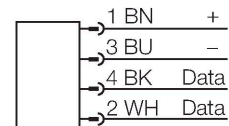

## Functional principle

The HF read/write devices operating at a frequency of 13.56 MHz form a transmission zone, the size of which (0...500 mm) varies depending on the combination of read/write device and tag used.

The read/write distances mentioned here only represent standard values measured under laboratory conditions, free from any influences caused by surrounding materials.

The read/write distances of the tags for mounting in metal TW-R\*\*-(MF) were determined in metal.

Attainable distances may vary by up to 30 % due to component tolerances, mounting conditions, ambient conditions and material qualities (especially when mounted in metal). Testing of the application under real operating conditions is therefore essential, especially with on-the-fly reading and writing!

## Mounting instructions/Description



Width active area 19 mm  
B

This figure illustrates an example of operating a read/write head in a compact multiprotocol I/O module TBEN-S\*-2RFID-\* or TBEN-L\*-4RFID-\* in a line topology

LED	Color	Status	Meaning
\\Graphics\Pic4\00185369_0.EPS			

Dimensions	Type designation	Read-write distance		Transfer zone		Minimum distance between two read-write heads [mm]
		Recommended (mm)	max. [mm]	length max. [mm]	width offset max. [mm]	
	Ident - no.					

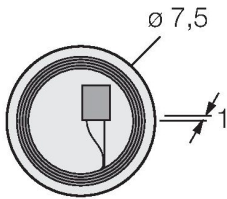
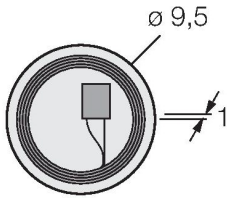
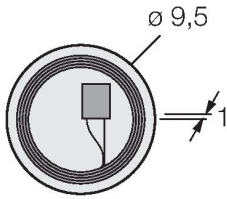
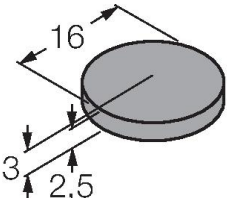
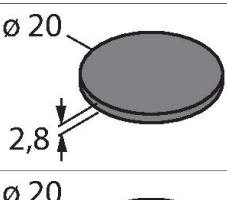
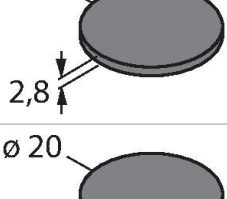
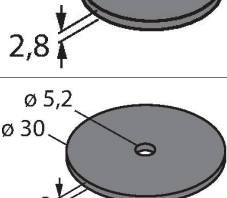
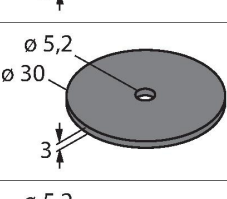
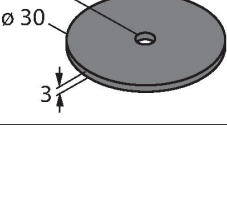
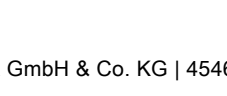
	<b>TW-R7.5-B128</b> 7030231	8	14	16	8	54
	<b>TW-R9.5-B128</b> 7030252	9	15	18	9	54
	<b>TW-R9.5-K2</b> 7030558	5	12	13	6	54
	<b>TW-R16-B128</b> 6900501	10	17	14	7	54
	<b>TW-R20-B128</b> 6900502	8	15	12	6	54
	<b>TW-R20-B320</b> 100005244	8	15	12	6	54
	<b>TW-R20-K2</b> 6900505	5	12	16	8	54
	<b>TW-R30-B128</b> 6900503	8	17	22	11	54
	<b>TW-R30-B320</b> 100005245	8	17	22	11	54
	<b>TW-R30-K2</b> 6900506	6	14	18	9	54

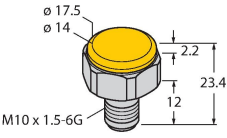
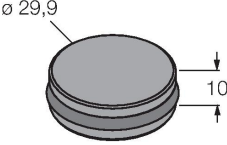
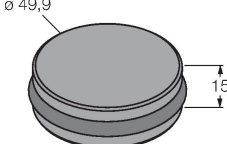
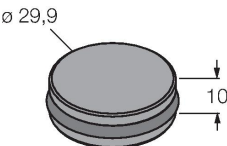
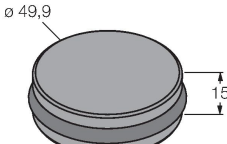
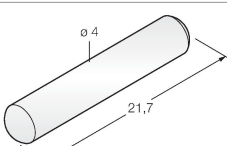
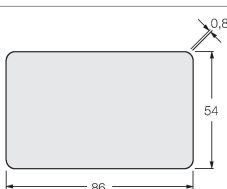
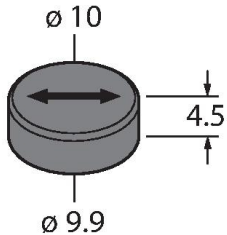
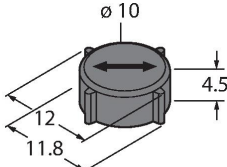
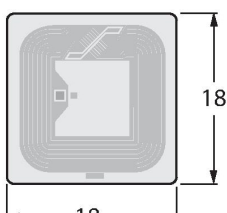
	<b>TW-BD10x1.5-19-K2</b> 6901381	6	14	16	8	54
	<b>TW-R30-M-B128</b> 7030210	8	12	16	8	54
	<b>TW-R50-M-B128</b> 7030209	8	18	22	11	54
	<b>TW-R30-M-K2</b> 7030206	7	10	18	9	54
	<b>TW-R50-M-K2</b> 7030229	7	15	24	12	54
	<b>TW-R4-22-B128</b> 7030237	3	9	12	6	54
	<b>TW-L86-54-C-B128</b> 6900479	10	21	70	35	54
	<b>TW-R10-M-B146</b> 7030545	5	7	10	3	54
	<b>TW-R12-M-B146</b> 7030500	5	7	10	3	54
	<b>TW-L18-18-F-B128</b> 7030634	7	13	14	7	54

	<b>TW-B58x1.25-19-K2</b> <b>7030638</b>	5	10	13	6	54
---	--	---	----	----	---	----

## Accessories

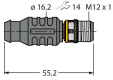
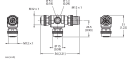
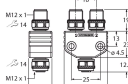
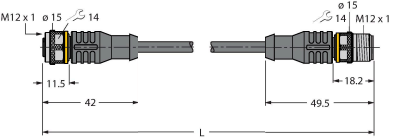
Dimension drawing	Type	ID	
	RSE57-TR2/RFID	6934908	Terminating resistor to build an RFID line topology
	VT2-FKM5-FKM5-FSM5	6930573	T-splitter to build an RFID line topology
	VB2-FKM5-FSM5.205-FSM5.305/S2550	6936821	Y-splitter for re-powering a supply voltage for the RFID bus topology
	RK4.5T-2-RS4.5T/S2503	7030331	BL ident cable, M12 female connector, straight to M12 male connector, straight, cable length: 2 m, jacket material: PUR, black; other cable lengths and qualities available, see <a href="http://www.turck.com">www.turck.com</a>