

P11-RI-QR24

Accessories – Positioning Element For Encoders RI-QR24

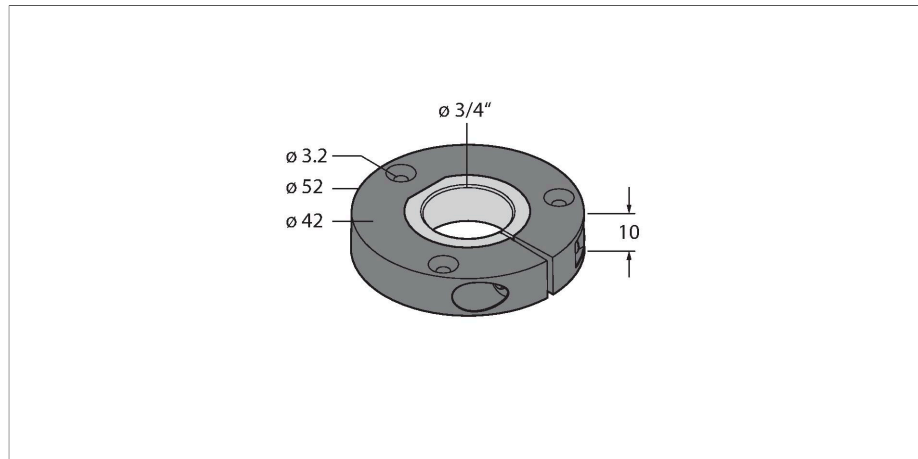

Features

- Positioning element, for Ø 3/4" shafts

Technical data

Type	P11-RI-QR24
Ident. no.	1593014
Housing material	Metal/plastic